

Thyristor Surge Suppressor

Features

- Excellent capability of absorbing transient surge
- Quick response to surge voltage (nS Level)
- Eliminates overvoltage caused by fast rising transients
- Moisture sensitivity level: level 1
- Weight:70mg
- Non degenerative
- Bi-directional

Exterior

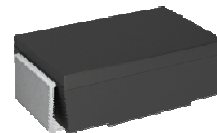

SMA

Application information

- Video

Package (top view)

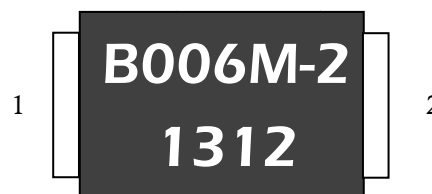

Agency Approvals

Icon	Description
<b>RoHS</b>	Compliance with 2011/65/EU

Schematic Symbol



Part Number and Electrical Parameter

Part Number	I <sub>DRM</sub> @V <sub>DRM</sub>		V <sub>S</sub> <sup>①</sup> @ I <sub>S</sub>		V <sub>T</sub> @ I <sub>T</sub>		I <sub>H</sub>	C <sub>o</sub> <sup>②</sup>
	μA	V	V	mA	V	A	mA	pF
	MAX		MAX		MAX		MIN	MAX
BS0060M-2	5	6	25	800	4	2.2	10	10

Absolute maximum ratings measured at T<sub>A</sub>= 25°C RH = 45%-75% (unless otherwise noted).

①V<sub>S</sub> is measured at 100KV/S

② Off-state Capacitance is measured at V<sub>DC</sub>=2V,V<sub>RMS</sub>=1V,f=1MHz

Thyristor Surge Suppressor

Part Numbering System

BS 0060 M - 2  
 (1) (2) (3) (4)

(1)Bencent Semiconductor Surge Arrester

(2)Off-state Voltage,e.g.0060=6 × 10<sup>0</sup>=6V

(3)Package :SMA

Rating Surge Voltage:3KV (1.2/50μs, 42Ω) , omitted in the Mark

(4)low capacitance

Mark

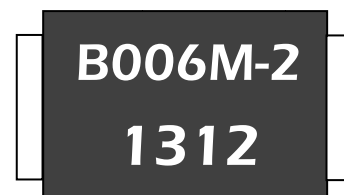

B006M-2: Part Number

1312:December,2013

V-I Curve

Parameters	Definition
V <sub>DRM</sub>	Peak Off-state Voltage
I <sub>DRM</sub>	Off-state Current
V <sub>S</sub>	Switching Voltage
I <sub>S</sub>	Switching Current
I <sub>H</sub>	Holding Current
V <sub>T</sub>	On-state Voltage
I <sub>T</sub>	On-state Current
C <sub>o</sub>	Off-state Capacitance

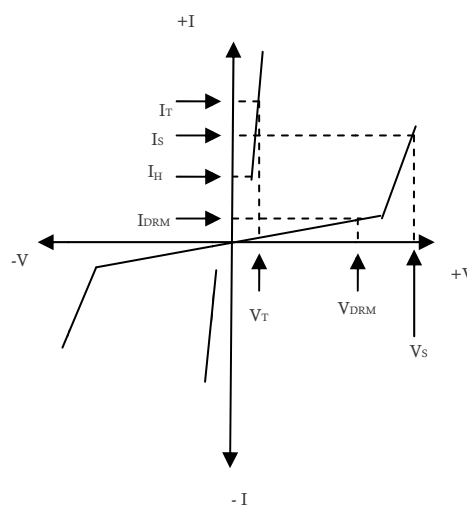

Surge Ratings

Current Waveform	8/20μs	10/1000μs
Voltage Waveform	1.2/50μs 42Ω	10/1000μs
I <sub>pp</sub>	72A	18A

-Peak pulse current rating(I<sub>pp</sub>)is repetitive and guaranteed for the life of the product;

-Bencent only makes the test for 8/20μs@72A(1.2/50μs 42Ω 3000V),but for other IPP value derived from experience is just for reference only. Bencent will not take any obligation for these parameters, so before applying our parts, please make sure to verify the parameters listed in the above table.

Thermal Considerations

Symbol	Parameter	Value	Unit
T <sub>J</sub>	Operating Junction Temperature Range	-40 to +125	°C
T <sub>S</sub>	Storage Temperature Range	-60 to +125	°C

Physical Characteristics

Lead Material	Copper Alloy
Body Material	UL recognized epoxy meeting flammability classification 94V-0
Terminal Finish	100% Matte-Tin Plated

**Environmental Characteristics**

Testing Items	Technical Standards
High Temperature Reverse Bias Test	Temperature: $150\pm 3^{\circ}\text{C}$ , Bias= $80\%V_{\text{DRM}}$ Time:168H
High Temperature Life Test	Temperature: $150^{\circ}\text{C}$ Time:168H
High-low Temperature Cycle Test	Temperature: From $-40^{\circ}\text{C}$ to $125^{\circ}\text{C}$ Dwell time: 30min, 10-100 cycles
High Temperature & High Humidity Test	Temperature: $85^{\circ}\text{C}$ Humidity:85% Test time:168H
Pressure Cooker Test	Temperature: $121^{\circ}\text{C}$ , 2atm. Humidity:100% Test time: 24H to 168H
Resistance of Soldering Heat	Temperature: $260\pm 5^{\circ}\text{C}$ Time of dip soldering: 10s, 3times

Note:The above testing items can be specified by customers by contacting Bencent service

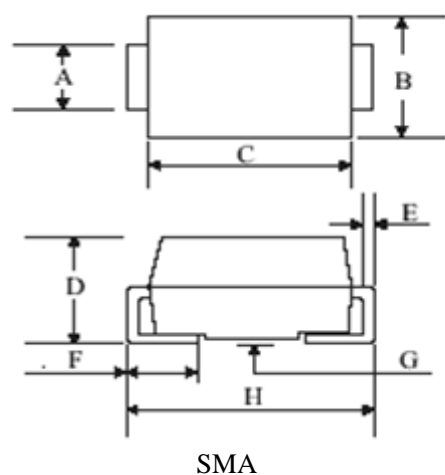
**Product Dimensions**

REF.	mm	inch
A	1.25-1.65	0.049-0.065
B	2.18-2.79	0.086-0.110
C	4.06-4.57	0.160-0.180
D	1.70-2.31	0.067-0.091
E	0.15-0.31	0.006-0.012
F	0.89-1.50	0.035-0.059
G	0.10-0.20	0.004-0.008
H	4.70-5.31	0.185-0.209

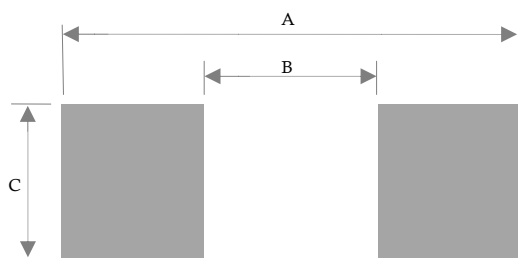
**Recommended Soldering Pad**

REF	mm	inch
A	6.00	0.236
B	2.00	0.079
C	2.00	0.079

**Thyristor Surge Suppressor**

Version: A0 2014-10-11

**Reflow Profile**

Reflow Condition		Pb-Free Assembly
Pre Heat	Temperature Min.	+150°C
	Temperature Max.	+200°C
	Time(Min to Max)	60 – 180 secs.
Average ramp up rate(LiquidusTemp( $T_L$ ) to peak)		3°C/sec. Max.
Ts(max) to $T_L$ - Ramp-up Rate		3°C/sec. Max.
Reflow	- Temperature ( $T_L$ ) (Liquidus)	+217°C
	- Temperature ( $T_L$ )	60 – 150 secs.
Peak Temp ( $T_P$ )		+(260+0/-5) °C
Time within 5°C of actual Peak Temp ( $T_P$ )		30secs.
Ramp-down Rate		6°C/sec. Max.
Time 25°C to peak Temp ( $T_P$ )		8 min. Max.
Do not exceed		+260°C

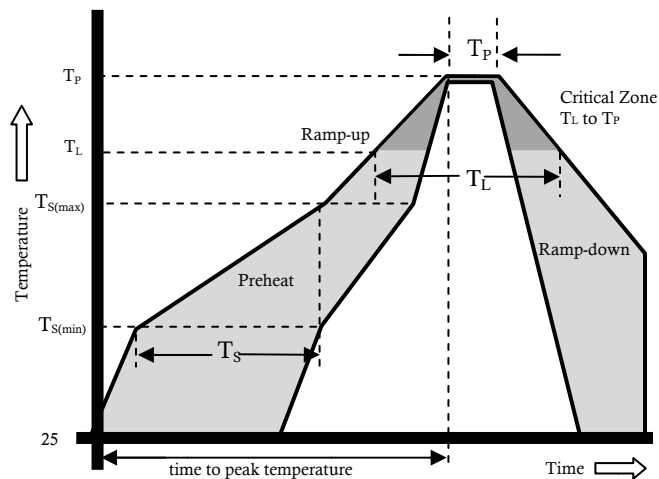
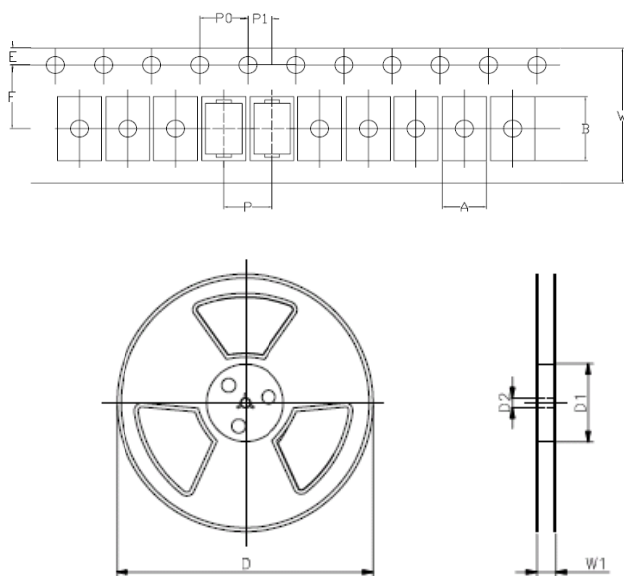
**Package Reel Information**

REF	mm	inch
A	2.6+/-0.15	0.102+/-0.006
B	5.15+/-0.15	0.203+/-0.006
d	1.5+/-0.1	0.059+/-0.004
D	330.0	13.0
D1	100+/-3	3.937+/-0.118
D2	13+/-0.3	0.512+/-0.012
E	1.5+/-0.2	0.059+/-0.008
F	5.65+/-0.2	0.222+/-0.008
P	4.0+/-0.2	0.157+/-0.008
P0	4.0+/-0.2	0.157+/-0.008
P1	2.0+/-0.2	0.079+/-0.008
W	12.0+/-0.2	0.472+/-0.008
W1	16.8+/-2.0	0.661+/-0.079

Outline	Reel (pcs)	Per Carton (pcs)	Reel Diameters (mm)	Carton Size(mm)		
				L	W	H
Taping	5,000	40,000	330	360	360	380